

Style "BT" Bare Process Thermocouple Elements

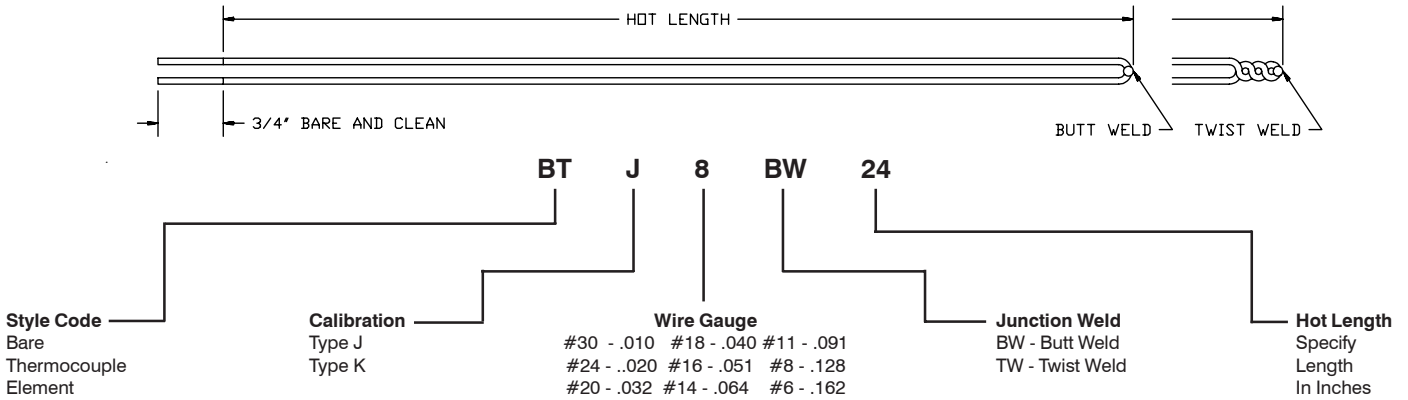

Style "SCT" Straight Ceramic Beaded Process Thermocouple Elements

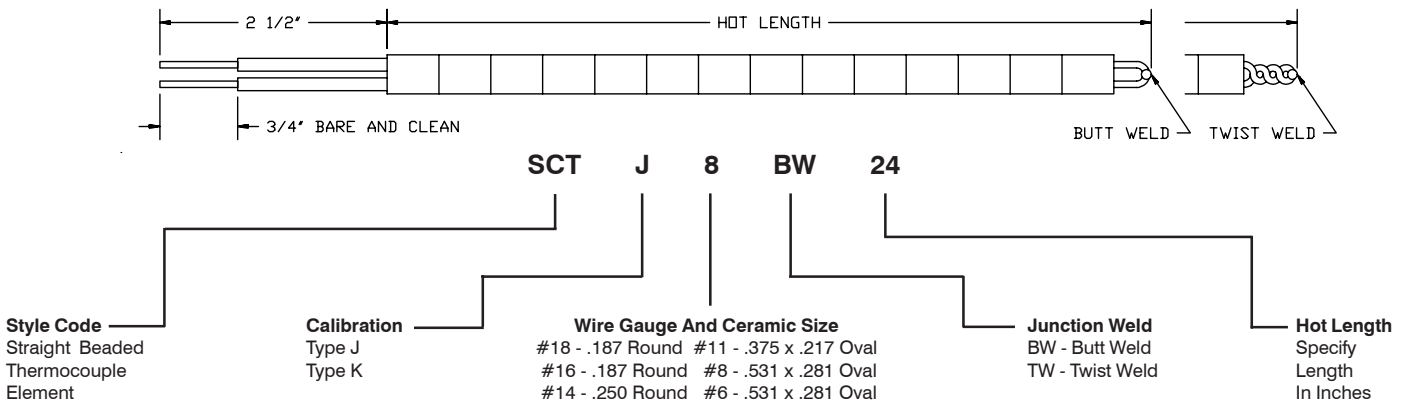

Style "BCT" Bendable Ceramic Beaded Process Thermocouple Elements

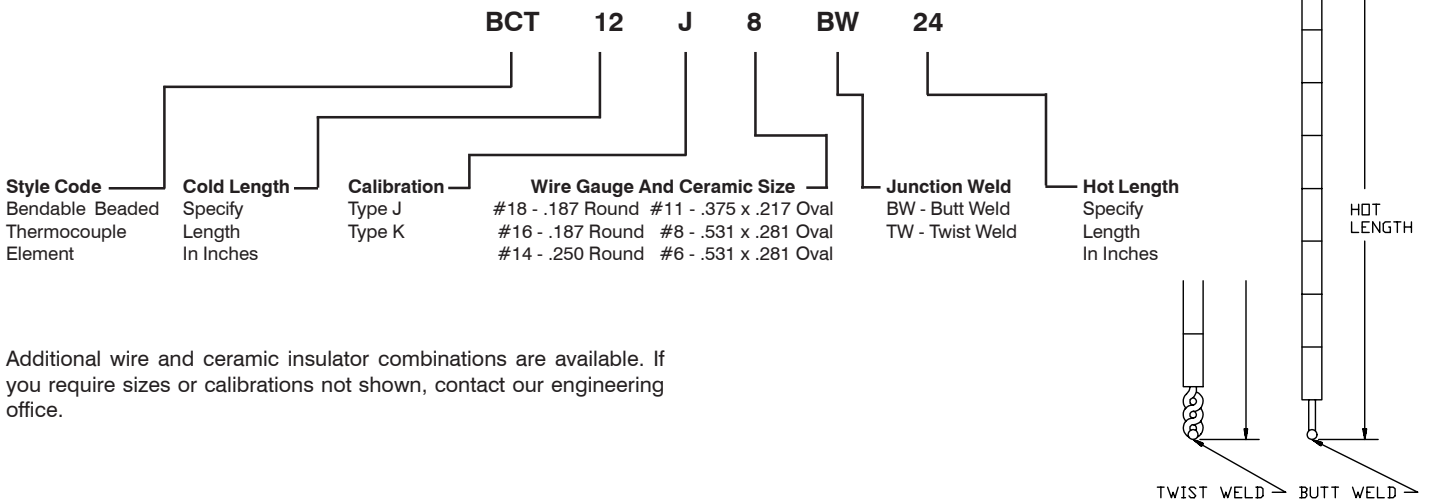

Additional wire and ceramic insulator combinations are available. If you require sizes or calibrations not shown, contact our engineering office.

The standard protection tubes shown below are available in assorted materials suitable for many common industrial processing applications. Special protection tubes in a variety of shapes and sizes can also be supplied when required.

Complete protection tube and sensor assemblies can be ordered by specifying the desired protection tube and noting that an assembly in some specific calibration is required. The heads are equipped with internal terminal blocks.

Style "PP" Straight Pipe Protection Tubes

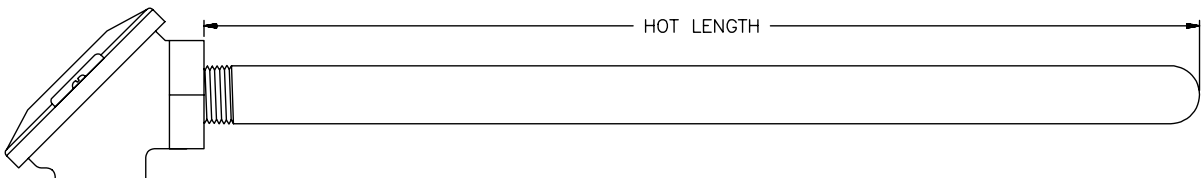

Style "PP" Straight Pipe Protection Tube Product Code

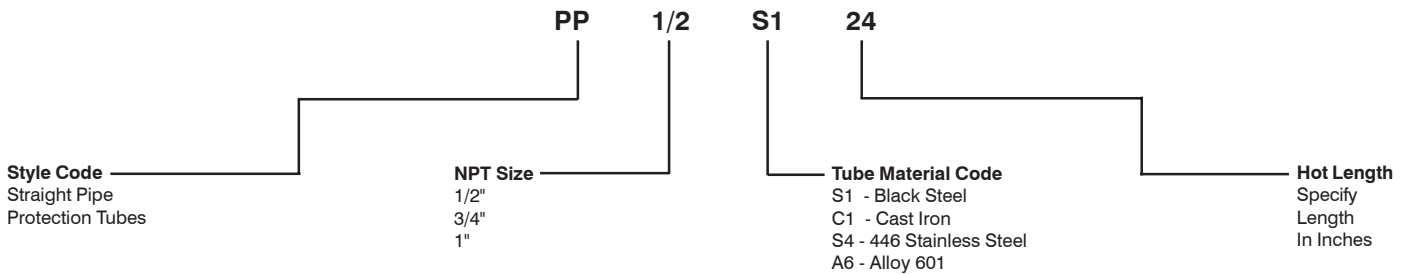

Style "PPA" Angled Pipe Protection Tubes

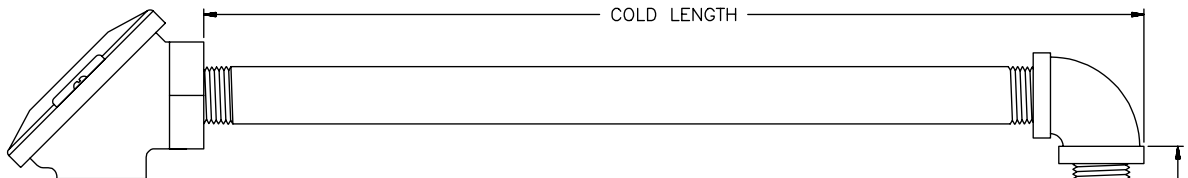

Style "PPA" Angled Pipe Protection Tube Product Code

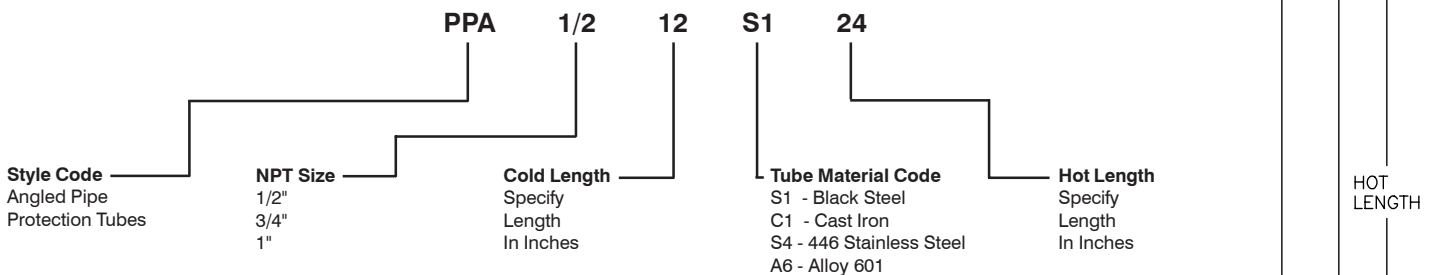

Cold lengths of the protection tubes will be supplied as black steel unless requested otherwise on your order. Note that additional cold sections can be specified on both straight and angled protection tubes. Angled probes can also be supplied in a 45 degree cold length extension angle.